

KENWOOD

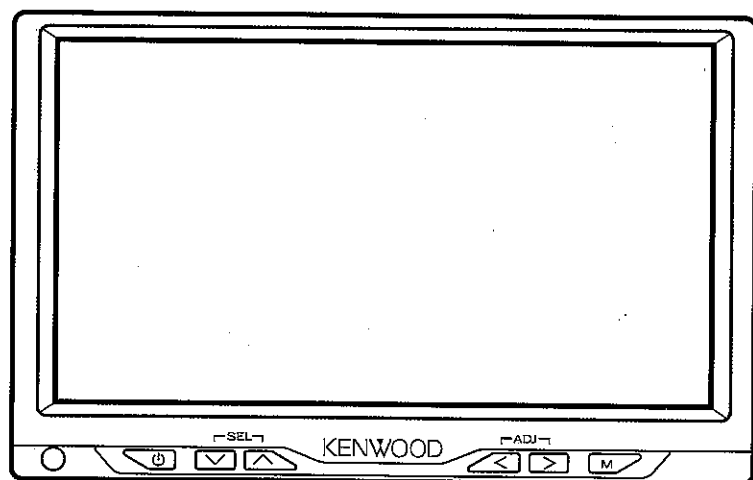

6.5" WIDESCREEN MOBILE MONITOR

LZ-6500W

**INSTRUCTION
MANUAL**

KENWOOD USA CORPORATION

KENWOOD

CONGRATULATIONS!

Your LZ-6500W monitor lets rear-seat passengers enjoy audio/video entertainment from its 6.5" wide LCD screen and headphone output. This manual will let you familiarize yourself with all of the LZ-6500W's features and capabilities.

For the latest information about this and other Kenwood products, visit the Kenwood USA Corporation Web site at: www.kenwoodusa.com

Box contents

Unpack your LZ-6500W carefully and make sure that everything shown here is present:

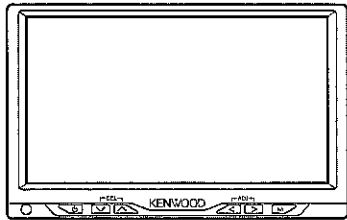

1 x LZ-6500W Mobile Monitor

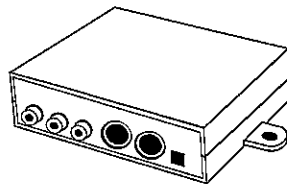

1 x Hideaway Box

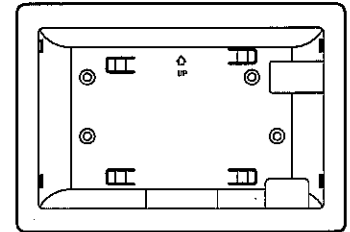

1 x Trim Ring/Mounting Bezel

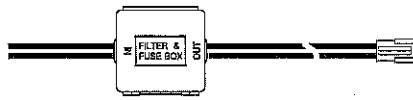

1 x Power Wire Harness

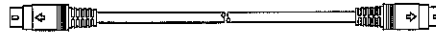

1 x Monitor Connection Cable

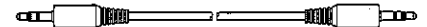

1 x DVD Control Cable

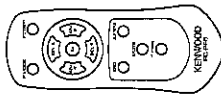

1 x Remote Control

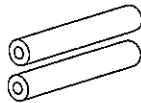

2 x AAA Batteries

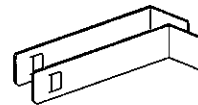

2 x Removal Tool



4 x Mounting Screws

If anything is missing or damaged, or if your LZ-6500W fails to operate, notify your dealer immediately. If your LZ-6500W was shipped to you directly, notify your shipper immediately. Kenwood recommends that you retain the original carton and packing materials in case you need to ship your LZ-6500W in the future.

Table of Contents

Safety Precautions	3
Front Panel Controls and Features	4
Remote Control Functions	4
Basic Operation	5
Using the On-Screen Menu	5
Installing the LZ-6500W	6
Troubleshooting Guide	7
Specifications	7

Safety Precautions

WARNING

To prevent injury and/or fire, take the following precautions:

- To minimize the risk of improper installation, Kenwood recommends that the installation of this product be performed by an MECP-Certified professional installer. Improper installation may cause damage to the vehicle or injury to the driver and occupants.
- Installation must be performed according to this product installation manual. Kenwood is not responsible for damages or injuries resulting from installation not performed strictly in accordance with the procedures described in this manual.
- Ensure that the unit is securely installed. Otherwise it may fly out of place during collisions and other jolts.
- Do not install the monitor so that the screen can be seen by the driver while operating the vehicle.
- When installing the monitor, make sure it will not obstruct the deployment of an airbag. Install the monitor away from heater ducts or vents.
- When extending the ignition or ground wires, make sure to use automotive-grade wire or other cables that are 18 gauge (AWG18) or thicker to prevent wire deterioration and damage to the wire coating.
- To prevent short circuits, never put or leave any metallic objects (e.g., coins or metal tools) inside the monitor or between the unit and the headrest mounting cup.
- If the unit starts to emit smoke or strange smells, turn off the power immediately and consult your Kenwood dealer.
- Be careful not to drop the monitor or subject it to strong shock—the unit may break or crack because it contains glass parts.
- Do not touch the liquid crystal fluid if the LCD is damaged or broken due to shock. The liquid crystal fluid may be dangerous to your health or even fatal. If the liquid crystal fluid from the LCD contacts your body or clothing, wash it off with soap immediately.
- This unit has no user-serviceable parts. Refer service to a qualified factory service center.

CAUTION

To prevent damage to the LZ-6500W, take the following precautions:

- Make sure to ground the unit to a negative 12V DC power supply.
- Do not open the back cover of the unit.
- Do not install the unit in a spot exposed to direct sunlight or excessive heat or humidity. Also avoid places with too much dust or the possibility of water splashing.
- Do not subject the monitor unit to excessive shock, as it is a piece of precision equipment.
- When replacing a fuse, only use a new one with the prescribed rating. Using a fuse with the wrong rating may cause your unit to malfunction.

- To prevent short circuits when replacing a fuse, first disconnect the wiring harness.
- Do not use any screws except for the ones provided. The use of improper screws might result in damage to the main unit.

RESETTING THE MICROPROCESSOR

If the unit does not seem to be working properly, turn the vehicle's ignition off, then on again. If that does not solve the problem, consult your Kenwood dealer.

FCC WARNING

This equipment may generate or use radio frequency energy. Changes or modifications to this equipment may cause harmful interference unless the modifications are expressly approved in the instruction manual. The user could lose the authority to operate this equipment if an unauthorized change or modification is made.

NOTE

This equipment has been tested and found to comply with the limits for a Class B digital device, pursuant to Part 15 of the FCC Rules. This equipment may cause harmful interference to radio communications if it is not installed and used in accordance with the instructions. However, there is no guarantee that interference will not occur in a particular installation. If this equipment does cause harmful interference to radio or television reception, which can be determined by turning the equipment off and on, the user is encouraged to try to correct the interference by one or more of the following measures:

- Reorient or relocate the receiving antenna.
- Increase the separation between the equipment and receiver.
- Connect the equipment into an outlet on a circuit different from that to which the receiver is connected.
- Consult the dealer or an experienced radio technician for help.

NOTE

This Class B digital apparatus, complies with Canadian ICES-003. This video unit is set for rear passenger use only. Use of this video unit in any front seat and/or where it may be visible to the driver may be illegal in some states and may cause driver distraction and an accident, resulting in injury or death.

Warnings

- Do not use any solvents or cleaning materials when cleaning the video system.
- Do not use any abrasive cleaners—they may scratch the screen. Use only a lightly-dampened lint-free cloth to wipe the screen if it becomes dirty.
- Watching the monitor for an extended time with the vehicle's engine off can drain the vehicle's battery.
- Do not put pressure on the LCD screen.
- Caution children to avoid touching or scratching the screen, as it may become dirty or damaged.

KENWOOD

Front Panel Controls and Features:

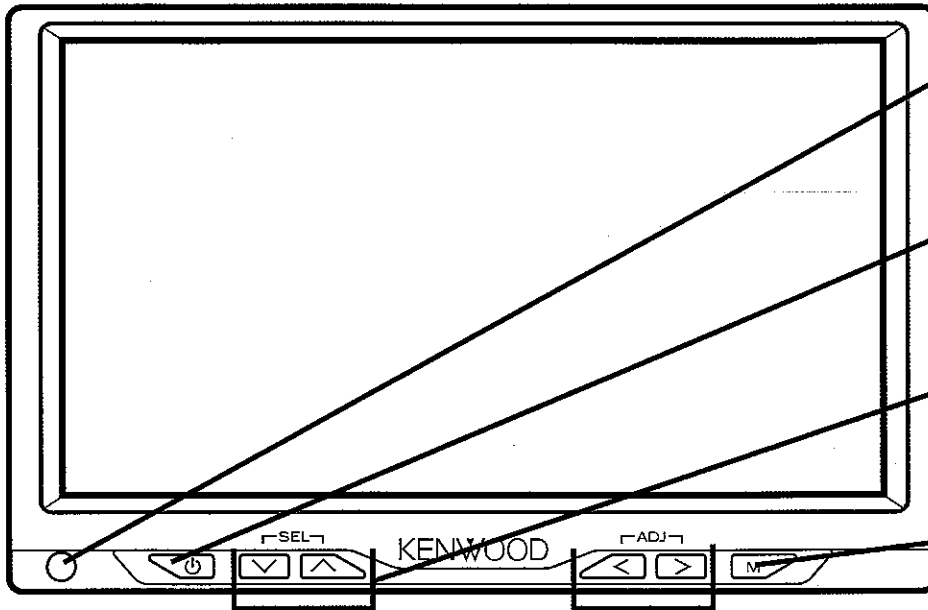

Remote control IR sensor:
Receives signals from the included wireless remote.

Power button:
Press to turn the monitor on and off.

Selection buttons:
Press to select different menu functions.

M (menu) button:
Press to activate the on-screen menu system.

ADJ (adjust) buttons:
Press to adjust the selected menu function.

Remote control functions:

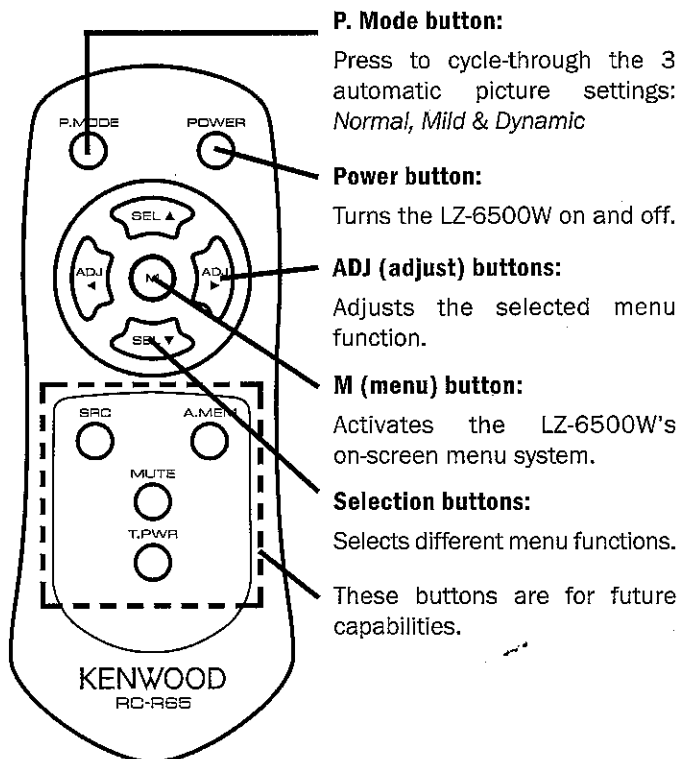

P. Mode button:
Press to cycle-through the 3 automatic picture settings: *Normal, Mild & Dynamic*

Power button:
Turns the LZ-6500W on and off.

ADJ (adjust) buttons:
Adjusts the selected menu function.

M (menu) button:
Activates the LZ-6500W's on-screen menu system.

Selection buttons:
Selects different menu functions.

These buttons are for future capabilities.

Installing Batteries in the Remote:

1. Remove the battery cover as shown below.
2. Install two AAA batteries with their poles as shown below.
3. Replace the battery cover.

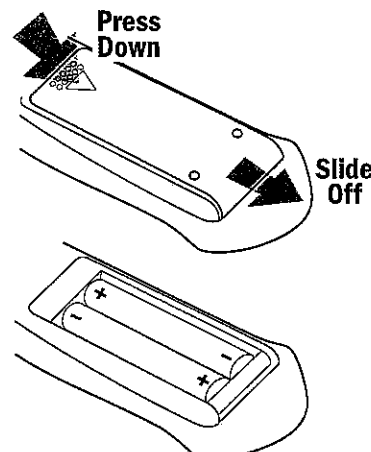

NOTE:
The supplied batteries are for operational checks, and may not last as long as regular alkaline batteries. When the remote-controlable distance is reduced, replace both batteries with new ones.

CAUTION:
Do not leave the remote in direct sunlight, such as on the dashboard.

KENWOOD

Basic Operation

Turning the monitor on and off

1. Press the  (power) button on either the monitor or the remote control.
2. Turn the power on for the external source you want to watch.

Using the On-Screen Menu

1. Press the M (menu) button to activate the on-screen menu.
 - The menu items will be superimposed on the screen over the video image.
2. Use the SEL buttons to highlight the item you want to adjust.
3. Use the ADJ (adjust) buttons to perform the adjustment.

On-Screen Menu Items

INPUT selector

Select a source connected to the LZ-6500W's hideaway box.

CONTRAST setting

Increase or decrease the whiteness in the picture.

BRIGHTNESS setting

Make the picture brighter or darker.

COLOR setting

Increase or decrease the color depth.

TINT setting

Tint the color towards red or green.

Automatic Picture Control

Press the P. MODE button on the remote to cycle-through the LZ-6500W's 3 automatic picture settings:

- Normal: Normal color, brightness and contrast.
- Mild: Reduced color, brightness and contrast, for viewing at night or in lower-light conditions.
- Dynamic: Increased color, brightness and contrast, for viewing in the daytime or in bright light conditions.

Screen Mode settings

The LZ-6500W's LCD screen is a widescreen (16:9) format. Since a conventional video picture (4:3 format) will not fill the screen completely, you can select from three different ways to view a 4:3 picture.

1. Press the M (menu) button to activate the on-screen picture control menu.
2. Use the SEL buttons to highlight "SCREEN".
3. Use the ADJ (adjust) buttons to cycle-through the following screen modes:

Wide Picture mode

The 4:3 picture is stretched so it fills the entire width of the LZ-6500W's screen. The image will appear distorted (wider than normal).

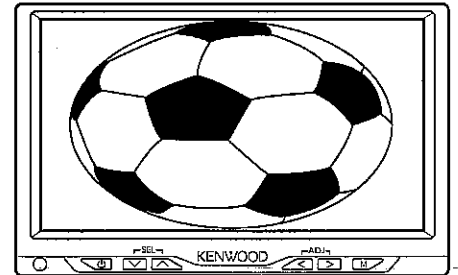

Full mode

Zooms-in on the central portion of the 4:3 picture, stretching the image vertically. The edges of the image are stretched horizontally to fill all of the LZ-6500W's screen. The image will appear distorted, and video resolution will be reduced.

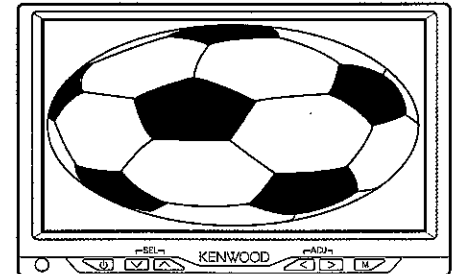

Normal mode

The entire 4:3 picture is displayed without alteration in the center 75% of the LZ-6500W's screen, with gray bars on either side (called "window-boxing").

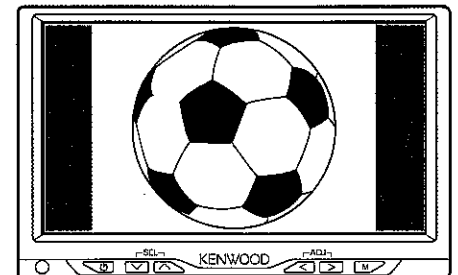

KENWOOD

Installing the LZ-6500W

Connect the monitor and hideaway box as shown in the diagram below.

- You can connect up to 2 audio/video sources to the hideaway box (use the cables supplied with the source components).
- You can connect the hideaway box to a second video monitor and an audio system that has an aux input.
- If you're using the LZ-6500W with a compatible Kenwood DVD player, connecting the Remote Pass-Thru Cable will allow the LZ-6500W's remote to control it as well as the monitor.
- You can use the included Trim Ring/Mounting Bezel to flush-mount the LZ-6500W.

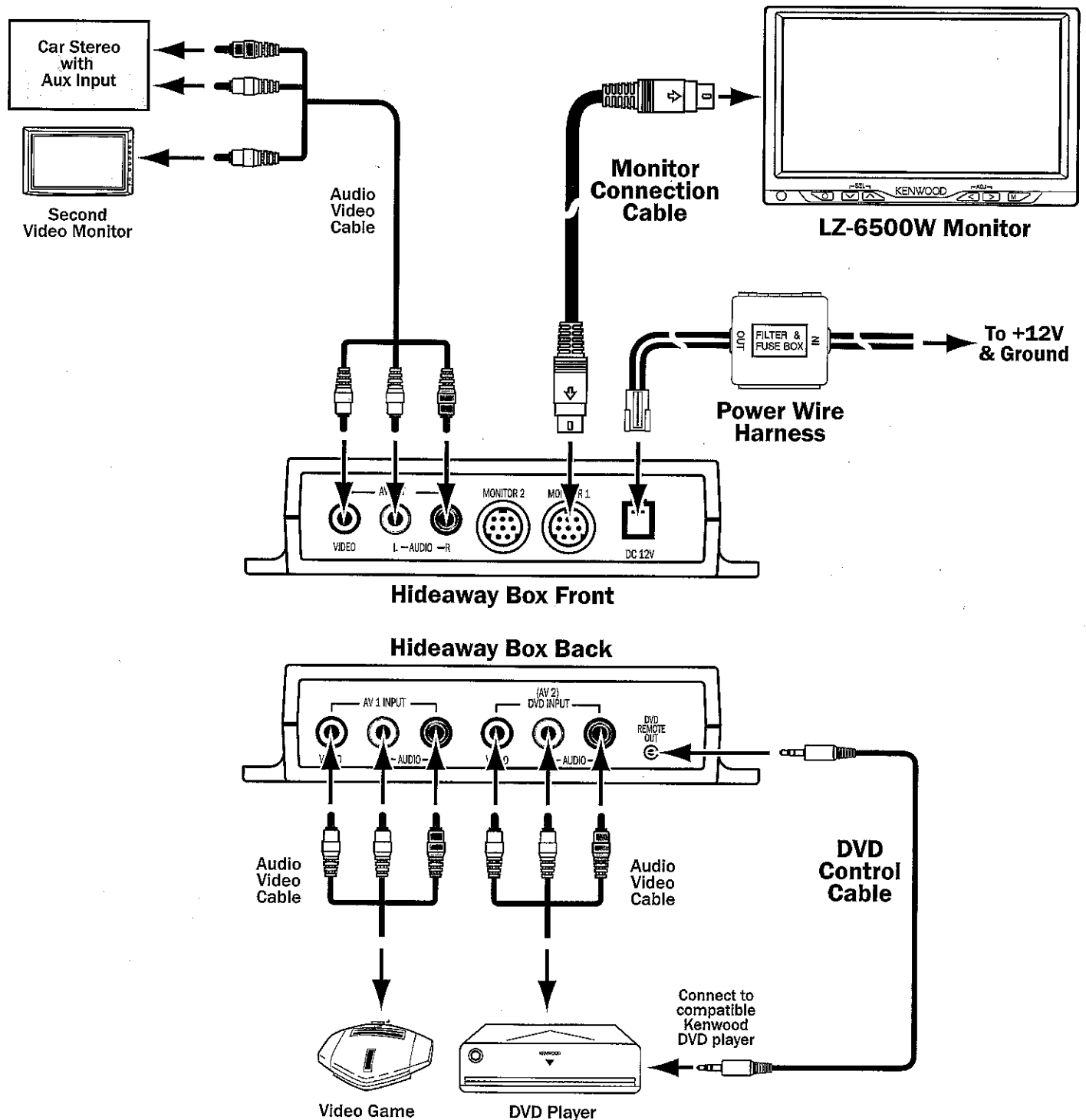

Troubleshooting Guide

What might appear to be a malfunction in your unit may just be the result of misoperation or miswiring. Before calling for service, first check the following for possible problems.

PROBLEM	CAUSE	SOLUTION
The monitor does not power-up	The fuse has blown The vehicle's ignition lacks an ACC position	Replace the fuse with one of the same rating Connect the monitor's ignition wire and battery wire together
Buttons do not operate, or operate erroneously	The microprocessor is malfunctioning	Reset the microprocessor (see 'Resetting The Microprocessor' on page 3)
No video picture	Improper connection(s) to video source(s)	Verify that the video sources are properly connected
The video image is dark	The screen is cold	Liquid Crystal Display screens may appear darker when they are cold. Once you turn the console's power on and the screen's temperature rises, its normal brightness will return.

Specifications

Screen Size6.5" (diagonal)
 LCD Display Aspect Ratio16:9
 LCD Display Total Resolution280,800 pixels*
 Viewing Angle+40°/-65° (vertical), 120° (horizontal)
 Brightness400 cd/m²
 Video Input (Composite Signal)1.0Vp-p/75ohms
 Audio Input1V/22kOhms
 Video Output (Composite Signal)1.0Vp-p/75ohms

Audio Output1V/1kOhm
 Dimensions6³/₈" (W) x 4" (H) x 1" (D)
 Weight0.64 lb
 Operating VoltageDC 11V ~16V
 Power Consumption0.167A ~ 1.0A
 Operating Temperature14°F - 140°F (-10°C - +60°C)

* Although the effective pixels for the liquid crystal panel is given as 99.9999% or more, 0.0001% of pixels may not light or may light incorrectly.

KENWOOD

www.kenwoodusa.com

www.kenwoodusa.com/inquiry

1-800-KENWOOD

Main Office

P.O. Box 22745
Long Beach, CA 90801-5745

Canada Office

6070 Kestrel Road
Mississauga, Ontario L5T 1S8